

# ZenWall™ Modern



Flip or Rotate



Retaining Wall



Garden Wall



Outdoor Stairs



Pillars & Posts

# Simplified Installation Standard Block

ZenWall is a modern wall block that is specifically made to be flipped or rotated when installed to randomize protruding elements **UP** or **DOWN**. There are no pins or clips required, everything has been designed into the block. The following will provide easy installation and a beautiful random final appearance to the wall.

## Straight Walls | Modern Architectural Design

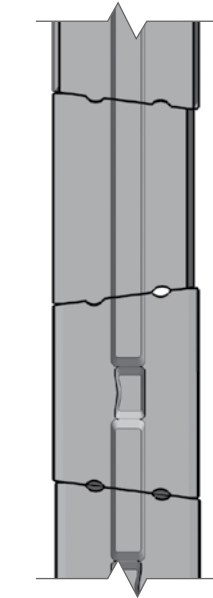

## Curved Walls | Min Radius 4.25' (1.3m)

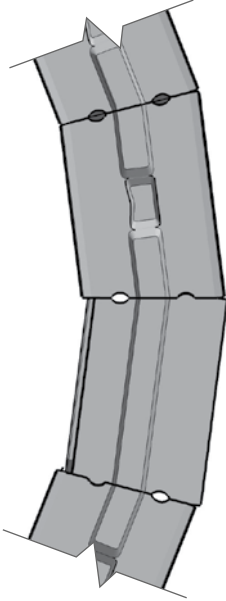

## Gravity Wall | Garden Walls & Planters

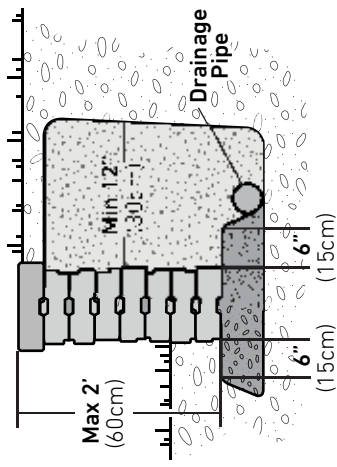

## Simple Recommended Installation | 2UP ▶ 2DOWN ▶ 1UP ▶ 1DOWN ▶ REPEAT...

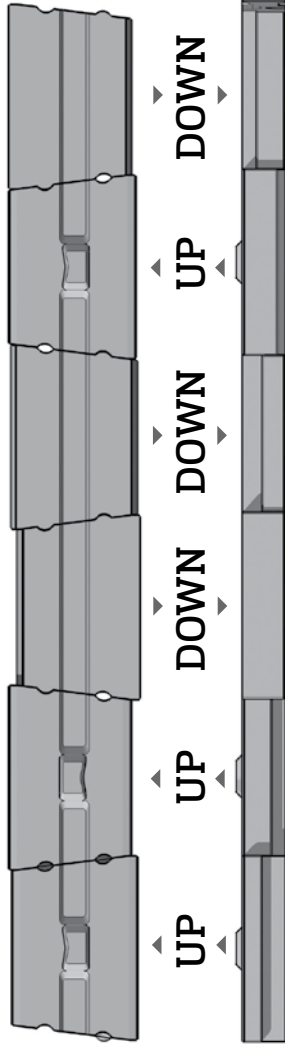

## Geogrid Reinforced Wall | High Walls & Raised Patios

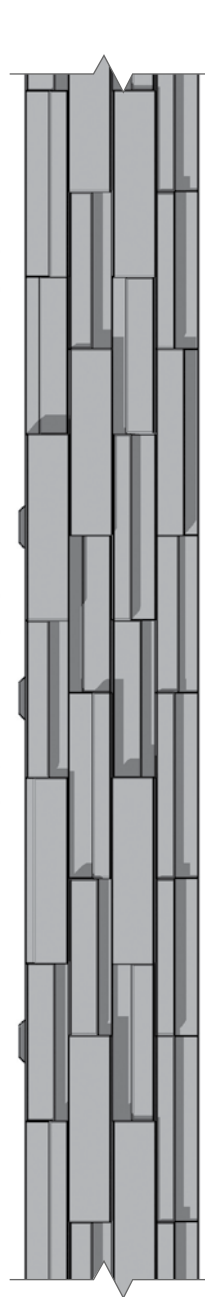
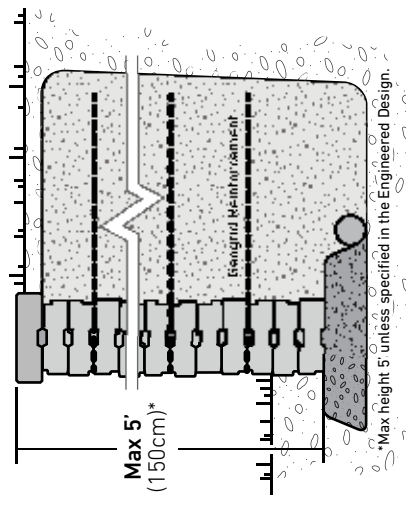

Since the bottom course is normally buried, these blocks can be installed in all **UP** position for easier construction.

**Expocrete**  
www.expocrete.com



**RisiStone**  
retaining wall systems

Please visit [www.risistone.com](http://www.risistone.com) for additional installation guides & construction details.



# ZenWall™ Modern



Flip or Rotate



Retaining Wall



Garden Wall



Outdoor Stairs



Pillars & Posts

# Simplified Installation Corner Block

ZenWall is a modern wall block that is specifically made to be flipped or rotated when installed to randomize protruding elements **UP** or **DOWN**. Because of this there are no specific "Left" or "Right" corners, as any block can work in most situations by simply flipping the block. There are no pins or clips required, everything has been designed into the block. The following will provide easy installation and a beautiful random final appearance to the wall.

## Constructing Corners

Randomise flipped **UP** or **DOWN** blocks in each corner

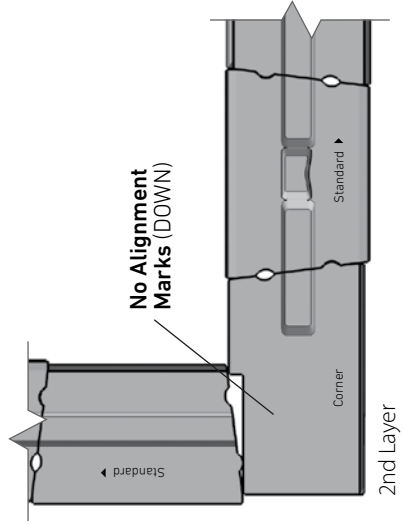
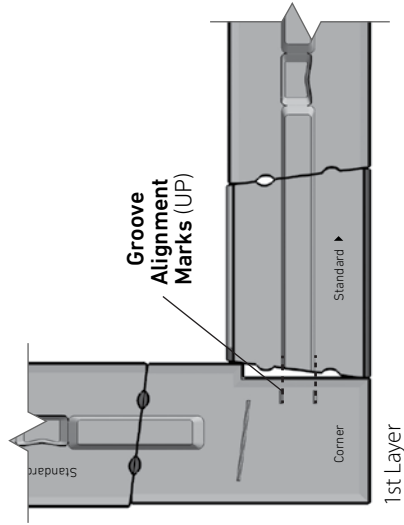

## Ending Seat Walls\*

Double sided with Factory Edges

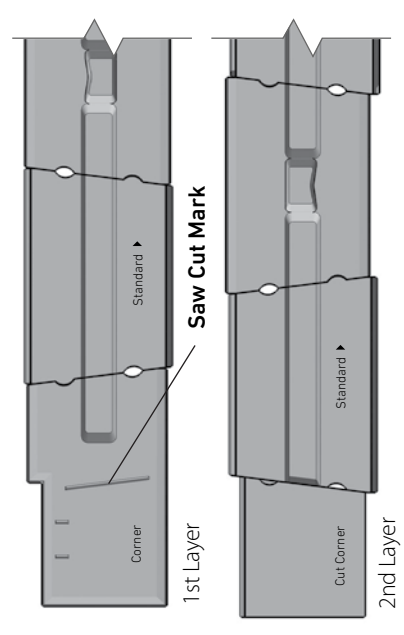

## Building Pillars\*

Randomise the number & position of flipped **UP** & **DOWN** blocks in each layer

1st Layer ▶ Clockwise



2nd Layer ▶ Counter Clockwise

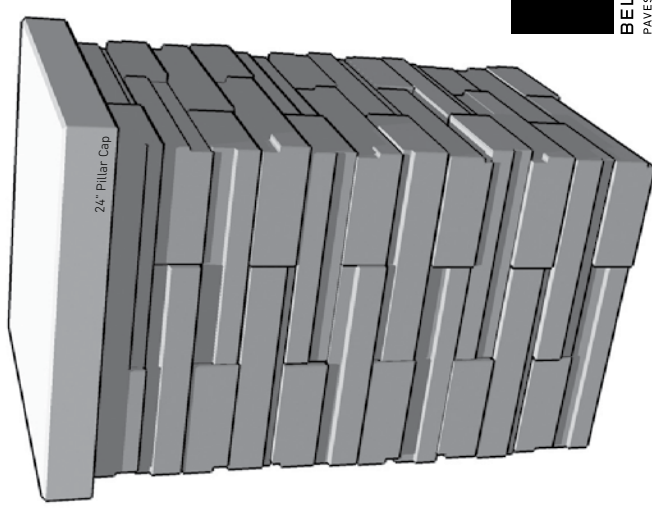

**Expocrete**  
www.expocrete.com



**RisiStone**  
retaining wall systems

\* Secure all blocks together with approved concrete adhesive. Please visit [www.risistone.com](http://www.risistone.com) for additional installation guides & construction details.

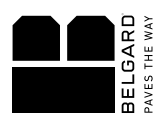

# ZenWall™ Modern



Flip or Rotate



Retaining Wall



Garden Wall



Outdoor Stairs



Pillars & Posts

## Simplified Installation Cap Block

ZenWall conveniently includes two Straight edge Cap Blocks in each pallet layer. These will provide a beautiful factory finished edge in most situations and greatly reduce the number of complicated cuts required. These should be saved and used when turning corners, stepping down the wall, ending double-sided seat walls and when there are visible step tread edges.

### Capping Corners

Cut a Tapered Block to fit

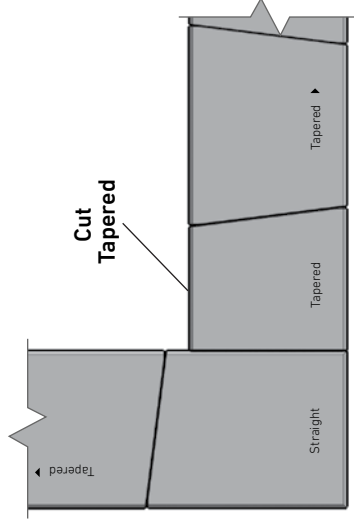

### Wall Step Downs

Closed-end seamless finish

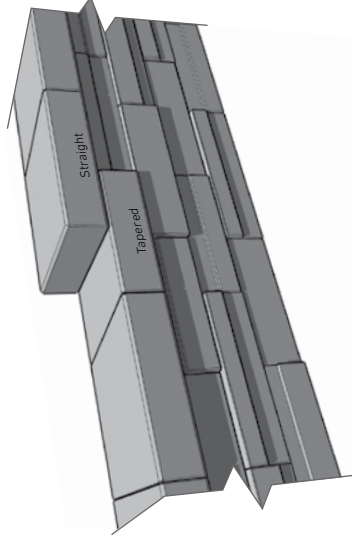

### Ending Seat Walls

Double-sided with Factory Edges

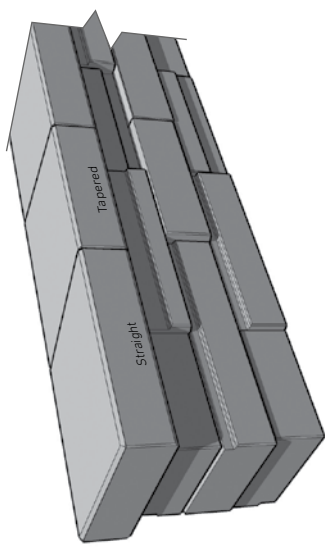

## But I have too many Straight Edge Caps ... What Now?

### Cut them into Tapered Caps

Matching finish

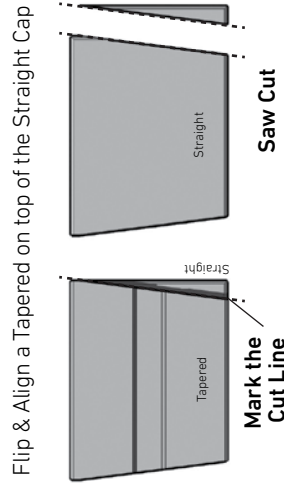

Flip & Align a Tapered on top of the Straight Cap

### Use Two in a Corner

No Cutting required

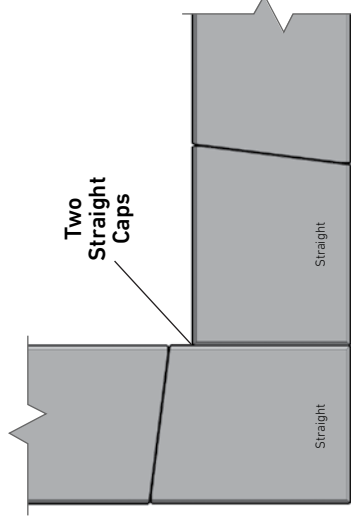

### Use them As Is

No Cutting quick installation

Use Two & align the Straight sides

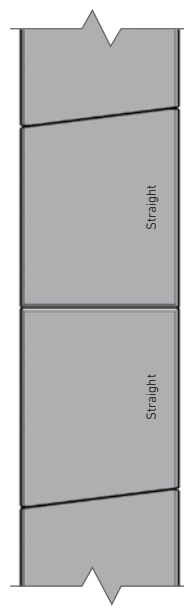

Or

Or

**Expocrete**  
www.expocrete.com



**RisiStone**  
retaining wall systems

Important: Secure all Cap blocks to the wall with approved concrete adhesive. Please visit [www.risistone.com](http://www.risistone.com) for additional installation guides & construction details.

